

- 1 Contents
- 2 About
- 3 Editorial Board – Technical Support
- 4 Information for Peers – Guiding Principles
- # Telecommunications Engineering – Applications
- 7 Self-Standing End-Fed Electrically Quasi-Uniform Linear Arrays: Analysis, Design, Construction, Measurements and FLOSS
K.Th. Kondylis, N.I. Yannopoulou, P.E. Zimourtopoulos



*This small European Journal is
In the Defense of Honesty in Science and Ethics in Engineering*

Publisher – otoiser—open transactions on independent scientific engineering research, www.otoiser.org–info@otoiser.org: Hauptstraße 52, 2831 Scheiblingkirchen, Austria

Language – We emphasize the origins of the Journal by using English, German and French, as well as, a Hellenic vignette in the cover page. However, since we recognize the dominance of US English in the technical literature, we adopted it as the Journal's language, although it is not our native language.

Focus – We consider Radio–FUNK, which still creates a vivid impression of the untouchable, and its Technology–TECHNIK, from an Advanced–PLUS point of view, Plus–PLUS Telecommunications Engineering, Electrical Engineering and Computer Science, that is, we dynamically focus at any related scientific-engineering research regarding Théorie, Expérimentation, Métrologie, Logiciel, ou Applications.

Scope – We emphasize this scope broadness by extending the title of the Journal with a Doppelkreuz-Zeichen # which we use as a placeholder for substitution of our Editorial Team disciplines: # Telecommunications etc. as above, or # High Voltage, # Software Engineering, # Simulation etc. as below.

Frequency – We publish 3 issues per year: on 31st of January, on 31st of May, and on 30th of September, as well as, an extra issue every 3 papers and a volume every 2 years.

Editions – We increase the edition number of an issue only when is needed to reform one or more of its papers—thus to increase their version numbers—but we keep unchanged its 1st edition date shown on its front page and we number its pages sequentially from 1. We count the editions of *About* separately.

Format – We use a fixed-space font, hyphenation, justification, unfixed word spacing, and the uncommon for Journals A5 (half A4) page size to achieve WYSIWYG printing and clear reading of 2 to 4 side-by-side pages on wide-screen displays.

Printing-on-Demand – We can email gratis PDF files at 300-4000 dpi in booklet page scaling of brochure and book type.

Copyright – We publish under a Creative Commons Attribution, CC-BY 3.0 Unported or CC-BY 4.0 International, License only.

Please download the latest *About* edition from
<http://about.ftpj.otoiser.org>

Editorial Team**# Electrical Engineering**

Professor Michael Danikas, mdanikas@ee.duth.gr
EECE, Democritus University of Thrace, Greece

High Voltage Engineering # Insulating Materials

Assistant Professor Athanasios Karlis, akarlis@ee.duth.gr
EECE, Democritus University of Thrace, Greece

Electrical Machines # Renewable Energies # Electric Vehicles**# Computer Science**

Professor Vasilis Katos, vkatos@bournemouth.ac.uk
Head of Computer and Informatics Dept, Bournemouth Univ, UK

Computer Engineering # Software Engineering # Cyber Security

Lecturer Sotirios Kontogiannis, skontog@gmail.com
Business Administration Dept, TEI, Western Macedonia, Greece

Internet Engineering # Learning Management Systems

Dr. Apostolos Syropoulos, asyropoulos@yahoo.com
BSc-Physics, MSc-Computer Science, PhD-Computer Science
Independent Researcher, Xanthi, Greece

Hypercomputation # Fuzzy Computation # Digital Typography**# Telecommunications Engineering**

Dr. Nikolaos Berketis, nberketis@gmail.com
BSc-Mathematics, MSc-Applied Maths, PhD-Applied Mathematics
Independent Researcher, Athens, Greece

Applied EM Electromagnetics # Applied Mathematics

Dr. Nikolitsa Yannopoulou, yin@arg.op4.eu [*]
Diploma Eng-EE, MEng-Telecom-EECE, PhD-Eng-Antennas-EECE
Independent Researcher, Scheiblingkirchen, Austria

Dr. Petros Zimourtopoulos, pez@arg.op4.eu [*]
BSc-Physics, MSc-Radio-Electronics, PhD-Antennas-EE
Independent Researcher, Scheiblingkirchen, Austria

Antennas # Metrology # EM Software # Simulation # Virtual Labs**# Applied EM # Education # FLOSS # Amateur Radio # Electronics***** Copy and Layout Editing, Proof Reading, Issue and Website Management, Paper and About Reprints, Volumes and Web Pages****Technical Support**

Konstantinos Kondylis, kkondylis@gmail.com
Diploma Eng-EECE, MEng-Telecom-EECE, Doha, Qatar
Christos Koutsos, ckoutsos@gmail.com
Diploma Eng-EECE, MEng-Telecom-EECE, Bratislava, SK

Information for Authors

This is a small, but independent, low profile Journal, in which we are all—Authors, Reviewers, Readers, and Editors—free at last to be Peers in Knowledge, without suffering from Journal roles or positions, Professional—Amateur—Academic statuses, or established "impact factorizations", under the following guiding principles:

Authors – We know what Work means, we respect the Work of the Independent Researcher in Science and Engineering and we want to exhibit his Work. Thus, we decided to found this Free and Open Access Journal in which to publish this Work. Furthermore, as we care indeed for the Work of the technical author—especially a young or a beginner one—we strongly support the publication of his Work, as follows:

- 1 We do not demand from the author to transfer his own copyright to us. Instead, we only consider papers resulting from original research work only, and only if the author can assure us that he owns the copyright of his own paper as well as that he submits to the Journal either an original copy or a revised version of his own paper, for possible publication after review—or even for immediate republication, if this paper has already been published after review—but, in any case under a Creative Commons Attribution, CC-BY 3 Unported or CC-BY 4 International, License, only.
- 2 We encourage the author to submit his own paper written just in Basic English plus Technical Terminology.
- 3 We encourage the author even to select a pen name, which may drop it at any time to reveal his identity.
- 4 We encourage the author to submit an accepted for publication paper, which he was forced to decline that publication because it would be based on a review with unacceptable evaluation or derogatory comments.
- 5 We encourage the author to submit any paper that was rejected after a poor, impotent, inadequate, unreasonable, irresponsible, incompetent, or "just ticking" review.
- 6 We encourage the author to submit an unreviewed paper of his own that he uploaded on some Open Access repository.
- 7 We encourage the author to upload his published paper in our Journal to at least one Truly Free Open Repository, e.g. such as <http://viXra.org> and <https://archive.org>.

- 8 We provide the author with the ability to update, at any time, the reference links of his paper.
- 9 We provide the author with a decent, express, peer review process, of up to just 4 weeks, by at least 2, either anonymous or onymous, reviewers.
- 10 We provide the author with the option to choose from 2 review processes: the traditional, anonymous, close one, as well as, a contemporary, onymous, open review in our private mailing list for Peer Discussion.
- 11 Under the Clause 1 : We immediately accept for publication a research paper directly resulting from a Project Report, or a Diploma-, Master-, or PhD-thesis, which already the author has successfully defended before a committee of experts, as long as he can mention 2 members of this committee who approved his Work.
- 12 Under the Clause 1 : We immediately accept for publication any paper which is not Openly Accessible on the Internet.
- 13 We immediately publish online a paper, as soon as it is accepted for publication in the Journal.
- 14 We quickly publish an extra issue—that is in excess of the 3 issues we publish a year—as soon as the review process of 3 papers is completed.

Reviewers – Every peer may voluntarily become a reviewer of the Journal in his skillfulness for as long as he wishes. In addition, each author of the Journal must review one paper in his expertness for each one of his published papers.

Readers – Every reader is a potential post-reviewer: we welcome comments and post-reviews in our private mailing list for Peer Discussion.

Editors – Every editor owns a PhD degree—to objectively prove that he really has the working experience of passing through the dominant publishing system. An editor pre-reviews a paper in order to check its compliance to our guiding principles and to select the appropriate reviewers of it. We can accept for consideration papers only in the expertise areas currently shown in the Editorial Team page, above. However, since we are very willing to amplify and extend the Scope of the Journal, we welcome the volunteer expert, in any related subject, who wants to join the Editorial Team as long as he unreservedly accepts our guiding principles.

Electronic Publishing

We regularly use the Free Libre Open Source Software Libre Office with the Free Liberation Mono font and the Freewares PDFCreator and PDF-Xchange Viewer. We also use, with some basic html code of ours: the Free Open Source Software Open Journal System OJS by the Public Knowledge Project PKP installed in our website, and the Free Open Digital Library of Internet Archive website, where we upload the FTP#J Collection of Issues, Paper reprints, *About* documents, and Volumes, in both portrait and landscape orientations, for download or very clear online reading with the Free Open Source BookReader.

Submissions

We can only consider papers written in the preferable and recommended odt format of LibreOffice, or even a paper in the MS Office with MathType doc format, if it would be proved that it is fully compatible with LibreOffice indeed.

Legal Notice – It is taken for granted that the submitter–correspondent author accepts, without any reservation, the totality of our publication conditions as they are analytically detailed here, in this *About*, as well as, that he also carries, in the case of a paper by multiple authors, the independent will of each one of his co-authors to unreservedly accept all the aforementioned conditions for their paper.

Internet Addresses

Submissions : sub@ftpj.otoiser.org
Send Updates : updates@ftpj.otoiser.org
Printing-on-Demand : pod@ftpj.otoiser.org
Technical Support TS : technical-support@ftpj.otoiser.org
Principal Contact : principal-contact@ftpj.otoiser.org
Peer Discussion List : www.peers.ftpj.otoiser.org
Editorial Team & TS List : www.etts.ftpj.otoiser.org
The FTP#J Collection at Internet Archive Digital Library :
<https://archive.org/details/@funktechnikplusjournal>
Sample Paper Templates : www.template.ftpj.otoiser.org
Reference Link Updates : www.updates.ftpj.otoiser.org
Internet Publishing : www.ftpj.otoiser.org

This document is licensed under a Creative Commons Attribution 4.0 International License – <https://creativecommons.org/licenses/by/4.0>

Self-Standing End-Fed Electrically Quasi-Uniform Linear Arrays: Analysis, Design, Construction, Measurements and FLOSS

K.Th. Kondylis, N.I. Yannopoulou, P.E. Zimourtopoulos *

Antennas Research Group, Athens, Greece [1]
Antennas Research Group, Austria [2, 3]

Abstract

Based on the analysis presented by the authors in their previous work for end-fed space arrays, where an application to geometrically uniform self-standing linear arrays of parallel dipoles was given, this paper presents the results of a single driving-point, self-standing, fully uniform linear array, that is one which has electrical uniformity, as well as, an application to the constrained pattern design. During the synthesis process and due to the multiplicity of solutions resulting from the complex analytical relations given here, the criterion of Electrically Quasi-Uniform Linear Array EQ-ULA was introduced. An experimental array model was designed, simulated, constructed, and its three main-plane radiation patterns were measured. The measurements were found in good agreement with analytical, computational, and theoretical results, and thus the proposed technique was experimentally proved. The developed software applications are available as FLOSS Free Libre Open Source Software.

Keywords

End-fed, single driving-point, self-standing arrays

Introduction

Fully Uniform Linear Arrays ULA are both geometrically GULA and electrically EULA uniform i.e. the dipoles are equidistant with consecutive dipole currents equal in amplitude and of constant phase difference, respectively

[1]. The complex vector radiation pattern of such an array is $E = AG$ where G is the Generator Pattern, and A is the Array Factor i.e. the complex numerical radiation pattern of N invented isotropic point sources, each of current I_k and pointed by the

dipole center vector R_k . Linear Arrays are those which have their corresponding point sources on a straight line.

Using the relations for end-fed, single driving-point, self-standing linear arrays presented in the previous author's work [2], where only the first condition of geometrical uniformity was imposed, the case of a fully ULA is examined here. Due to increasing complexity of current expressions with number of dipoles and for all other reasons that were detailed in [2], the ULA procedure is applied just for the simplest, next to trivial, linear array of three dipoles shown in Fig. 1.

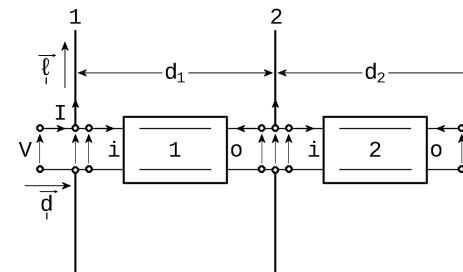

Fig. 1: End-fed linear array of 3 linear dipoles

Analysis

By applying the analysis presented in previous work [2] for $N = 3$ dipoles, $6N - 3 = 15$ linear relations between $6N - 2 = 15$ variables + 1 parameter, the source voltage V , result, as shown in Fig. 2 in

a compact form when $\beta l_1, \beta l_2 \neq v\pi, v = 1, 2, \dots$ for both transmission lines, with each cell value to be the coefficient of the variable in the first row of its column in an implied summation. For the case of $\beta l_1 = v\pi, v = 1, 2, \dots$ the two upper gray rows have to be substituted by the rows of Fig. 3 or 4, according to the odd or even value of v and similarly, if $\beta l_2 = v\pi, v = 1, 2, \dots$ the two last gray rows have to be substituted by those of Fig. 5 or 6.

The equivalent circuit is shown in Fig. 7. The GUI application form for the computation of current ratios of $N = 3$ dipoles, developed with Visual Fortran, is given in Fig. 8 [3], [4]. In this form, the input data are: the distances between dipoles, the dipole radius and length, the length, the characteristic impedance Z_0 , and the velocity factor v_f of each transmission line segment. In addition to current ratios, the application exports the text files needed by the [RadPat4W] application of the RGA FLOSS mini-Suite of tools [5]. The formulas for the determination of the $1 + 2 = 3$ current ratios (I_k/I_1) were mechanically verified using Mathematica. The expressions of the two current ratios ($I_2/I_1, I_3/I_1$) of the GUI are given by (1)-(5) below:

V_1	V_2	V_3	I_1	I_2	I_3	iV_1	oV_1	iI_1	oI_1	iV_2	oV_2	iI_2	oI_2	I	$=$	V
1															$=$	1
1						-1									$=$	0
			1					1						-1	$=$	0
	1									-1					$=$	0
	1							-1							$=$	0
				1					1			1			$=$	0
		1									-1				$=$	0
					1								1		$=$	0
						1									$=$	0
-1			Z_{11}	Z_{12}	Z_{13}										$=$	0
	-1		Z_{21}	Z_{22}	Z_{23}										$=$	0
		-1	Z_{31}	Z_{32}	Z_{33}										$=$	0
						-1		$i i Z_{1 i o} Z_1$							$=$	0
							-1	$o i Z_{1 o o} Z_1$							$=$	0
									-1		$i i Z_{2 i o} Z_2$				$=$	0
										-1	$o i Z_{2 o o} Z_2$				$=$	0

Fig. 2: The linear system of 15 relations for arrays with $N = 3$ and $\beta l_1, \beta l_2 \neq v\pi, v = 1, 2, \dots$

																$=$	0
																$=$	0

Fig. 3: 2 upper gray rows for $v = 2\mu + 1, \mu = 0, 1, 2, \dots$

																$=$	0
																$=$	0

Fig. 4: 2 upper gray rows for $v = 2\mu + 2, \mu = 0, 1, 2, \dots$

																$=$	0
																$=$	0

Fig. 5: 2 last rows replacement for $v = 2\mu + 1, \mu = 0, 1, 2, \dots$

																$=$	0
																$=$	0

Fig. 6: 2 last rows replacement for $v = 2\mu + 2, \mu = 0, 1, 2, \dots$

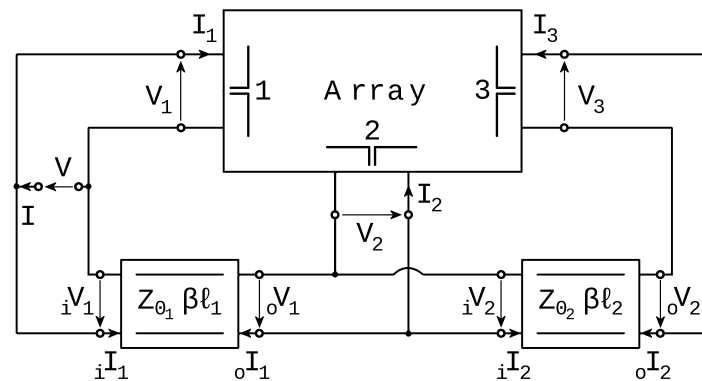

Fig. 7: Equivalent circuit of the 3 dipoles linear array

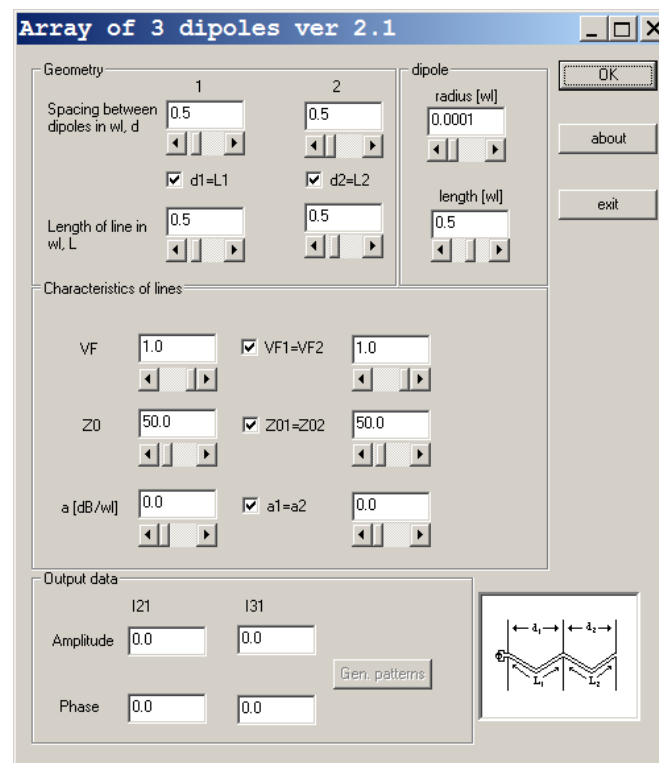

Fig. 8: GUI for the analysis of a linear array of $N = 3$ dipoles

$$I_{21} = \frac{I_2}{I_1} = \frac{A_{21}}{P} \quad (1)$$

$$I_{31} = \frac{I_3}{I_1} = \frac{A_{31}}{P} \quad (2)$$

$$A_{21} = [i_0 Z_2 (Z_{11} Z_{23} - Z_{12} Z_{13}) + i_i Z_2 (Z_{13}^2 - Z_{11}^2)] i_0 Z_1 + (Z_{11} Z_{12} - Z_{13} Z_{23}) i_i Z_1 i_i Z_2 + [Z_{12} (Z_{11} + i_i Z_2) - Z_{13} (Z_{23} + i_0 Z_2)] (i_i Z_1^2 - i_0 Z_1^2) - (Z_{11} i_0 Z_1 - Z_{12} i_i Z_1) (i_i Z_2^2 - i_0 Z_2^2) \quad (3)$$

$$A_{31} = [i_0 Z_2 (Z_{12}^2 - Z_{11}^2) + i_i Z_2 (Z_{11} Z_{23} - Z_{12} Z_{13})] i_0 Z_1 + (Z_{11} Z_{13} - Z_{12} Z_{23}) i_i Z_1 i_i Z_2 + [Z_{13} (Z_{11} + i_i Z_2) - Z_{12} (Z_{23} + i_0 Z_2)] (i_i Z_1^2 - i_0 Z_1^2) \quad (4)$$

$$P = [i_0 Z_2 (Z_{11} Z_{13} - Z_{12} Z_{23}) + i_i Z_2 (Z_{11} Z_{12} - Z_{23} Z_{13})] i_0 Z_1 + (Z_{11}^2 + Z_{23}^2) i_i Z_1 i_i Z_2 - [(Z_{11} + i_i Z_2)^2 + (Z_{23} + i_0 Z_2)^2] (i_i Z_1^2 - i_0 Z_1^2) + (Z_{12} i_0 Z_1 - Z_{11} i_i Z_1) (i_i Z_2^2 - i_0 Z_2^2) \quad (5)$$

in which the equality of self and mutual impedances resulting from the system of Fig. 2, have been taken into account.

rent ratios for a two-wire transmission line of $Z_0 = 200 \Omega$ and $vf = 1$, and Fig. 10 the phase difference between the consecutive dipoles, in terms of the s/λ distance, with minimum value 0.005 and maximum 1 . The two conditions imposed by EGULA or simply ULA are:

$$\left| \frac{I_3}{I_1} \right| = \left| \frac{I_2}{I_1} \right| = 1, \quad \angle \frac{I_2}{I_1} = \angle \frac{I_3}{I_2} = \alpha \quad (6)$$

ULA Synthesis and Design

The simplest end-fed linear array of three dipoles is the one with the interelement distance equal to the transmission line length. Fig. 9 shows the two amplitude cur-

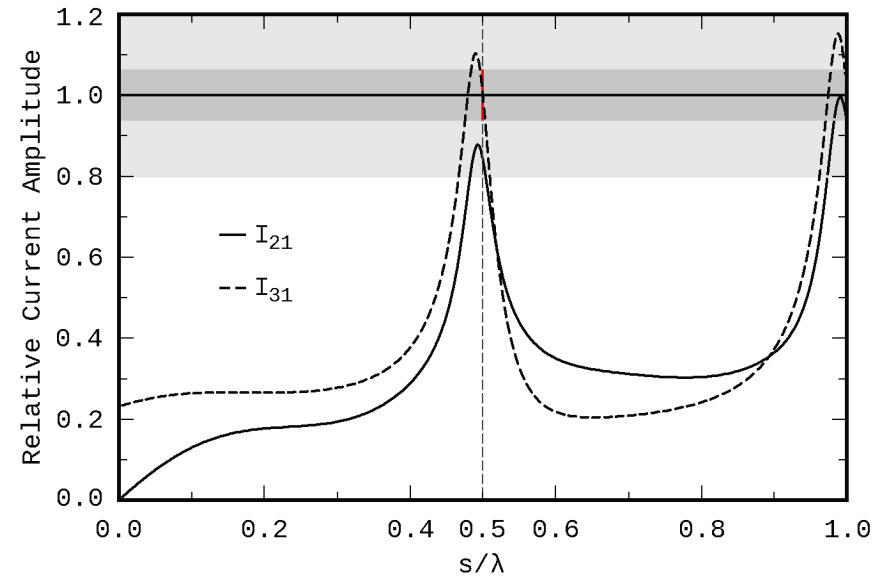

Fig. 9: Amplitude of current ratios for $s = d = \ell$

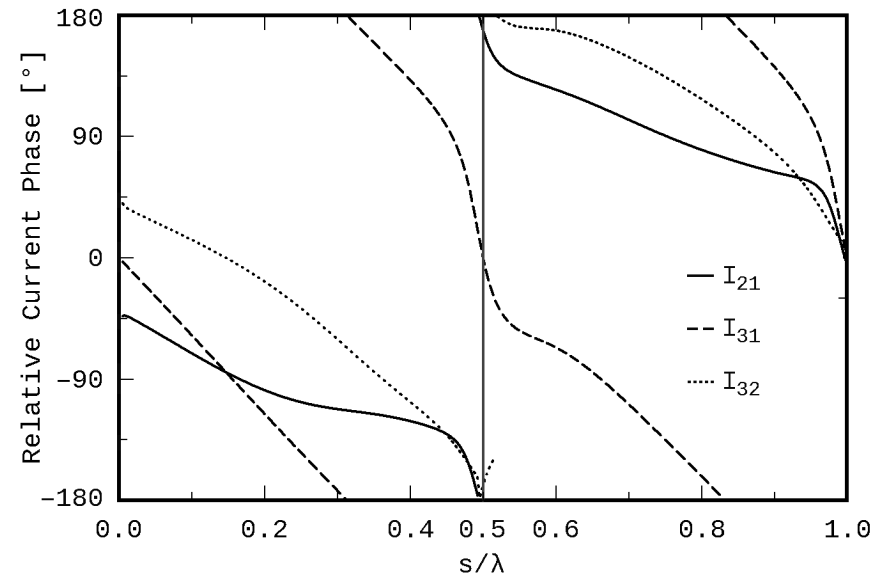

Fig. 10: Phase difference of current ratios for $s = d = \ell$

The value of $s=0.5\lambda$ was selected as the most probable to produce an ULA. The other possible value of s is near 1λ and leads to long distanced dipoles which are not mechanically suitable for an end-fed array. From these figures it is obvious that there is no uniform linear array which is ULA, with $s=d_1=d_2=l_1=l_2$, even by considering a $\pm 6\%$ variation from the desired value of the current ratios, as it is shown with the dark gray frame in Fig. 9. The only one array that could be an ULA, is the one with current ratio values which may be within the large light gray frame in Fig. 9, that is of a $\pm 20\%$ margin around 1, corresponding to the rather trivial case of an ULA with phase difference $\pm 180^\circ$, as this is indicated by the vertical dark gray line in Fig. 10.

Since the main purpose was to investigate the possibility of design, build and measure an end-fed self-standing ULA for use in practical applications, where just a few pattern constraints are imposed, the synthesis procedure is applied to the case of the 3 dipoles array.

Let suppose that it is required that the array factor A has a minimum in the direction of 45° and a maximum in 135° from the array axis, as

shown in Fig. 11, where A is the normalized array factor and $\xi_d \in [0, \pi]$ is the angle from the array axis to any direction.

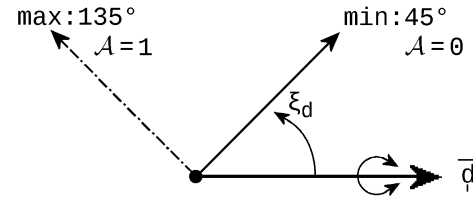

Fig. 11: Directions of A minimum and maximum

According to the above theory, the following two parameters define the ULA of 3 dipoles: constant phase difference α between consecutive dipoles and equidistance d/λ , as they are given by (6). There are two equivalent techniques to determine these two parameters:

i) the algebraic one, which involves the solution of a number of 2×2 systems of linear equations:

$$\begin{bmatrix} \cos \xi_d^a & 1 \\ \cos \xi_d^b & 1 \end{bmatrix} \begin{bmatrix} \beta d \\ \alpha \end{bmatrix} = \begin{bmatrix} \psi^a \\ \psi^b \end{bmatrix}, \quad \xi_d^a \neq \xi_d^b \Rightarrow$$

$$\beta d = \frac{\psi^a - \psi^b}{\cos \xi_d^a - \cos \xi_d^b} \quad (7)$$

$$\alpha = \frac{\psi^b \cos \xi_d^a - \psi^a \cos \xi_d^b}{\cos \xi_d^a - \cos \xi_d^b}$$

ii) the geometric technique of uniform array synthesis [1 p. 45].

Both of them are based on the periodic function:

$$A(\psi) = \frac{1}{N} \left| \frac{\sin(\frac{N\psi}{2})}{\sin(\frac{\psi}{2})} \right| \quad (8)$$

where $\psi = \beta d \cos(\xi_d) + \alpha$ with primary interval $(-\pi, \pi]$. $A(\psi)$ is drawn as in Fig. 12(a). The points on ψ axis give minimum (zero) values of A .

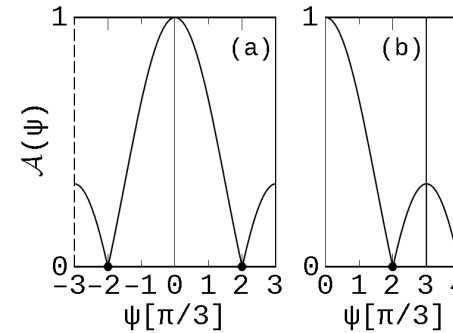

Fig. 12: ULA Array Factor A

Using the algebraic technique, the principal interval is searched for possible solutions first. Since $\psi^a = 0$ in our case, and

$$\cos \xi_d^a - \cos \xi_d^b = \cos \frac{3\pi}{4} - \cos \frac{\pi}{4} =$$

$$= -\frac{\sqrt{2}}{2} - \frac{\sqrt{2}}{2} = -\sqrt{2}$$

the solutions (7) are of the form

$$\beta d = \frac{\psi^b}{\sqrt{2}}, \quad \alpha = \frac{\psi^b}{2} \quad (9)$$

Therefore, the first zero of A at $\psi^b = -2\pi/3$ is rejected, because it results in a negative distance, as well as at any other negative ψ , while the second one at $\psi^b = 2\pi/3$ gives

$$\beta d = \frac{2\pi}{3\sqrt{2}}, \quad \alpha = \frac{\pi}{3} \Rightarrow$$

$$\Rightarrow d \simeq 0.25\lambda, \quad \alpha = 60^\circ \quad (10)$$

But, since this d value is only the half of $s=0.5\lambda$, another one solution is sought at $\psi^b = 4\pi/3$ in the extended interval to the positive ψ axis, as shown in Fig. 12(b). Hence, a third 2×2 system as (7) is formed with solution

$$\beta d = \frac{4\pi}{3\sqrt{2}}, \quad \alpha = \frac{2\pi}{3} \Rightarrow$$

$$\Rightarrow d \simeq 0.5\lambda, \quad \alpha = 120^\circ \quad (11)$$

in practice. This is the chosen solution and thus we have to look for a linear array of $N=3$ dipoles $d=0.5\lambda$ apart and with $\alpha=120^\circ$ phase difference.

After that, we successfully checked the above results by applying the geometric technique (ii), as it is

shown in Fig. 13, where ψ_{\max} is always equal to 0:

that is, the above solution (11).

This solution must satisfy the strict ULA requirements by using two segments of 200 $[\Omega]$ transmission line with appropriate length [2]. In practice, it is almost impossible to compromise all these analytical facts, since this issue is rather a matter of chance.

EQ-ULA design

In order to handle this practical problem we had the idea to somehow relax the ULA conditions by introducing the definition of the Electrically Quasi-Uniform Linear Array EQ-ULA as one with deviations $\pm\varepsilon$ and $\pm\delta$ to ULA conditions of unity 1 and α of (6). The ε , δ design criteria will be defined by the user as in the following.

A Visual Fortran application [SYN3DIP] was developed in order to support this definition for the case of $N=3$ dipoles, as shown in Fig. 14. The results of array synthesis are the input into the first frame, that is, the distance per wavelength d [wl] and the current phase difference in degrees α [deg] between successive dipoles. The next two frames correspond to the transmission line segments, which may have different or the same Z_0 and there is the possibility to search

between an initial and final value of Z_0 with a specified step. The deviation margins, and their initial values for this EQ-ULA were chosen as $\varepsilon = \pm 20\%$, and $\delta = \pm 10^\circ$.

The program execution results more than hundred (100) combinations of βl_1 , βl_2 in $[\circ]$ satisfying these two criteria. Fig. 15 shows the processed results from [SYN3DIP] where the minimum and maximum value of βl_2 are given inside each bar for every value of βl_1 . Amplitude and phase difference are given in Fig. 16 and Fig. 17 respectively. From these figures, it is obvious that the most possible solutions are between 198 and 202 for βl_1 . The value $\beta l_1 = 200^\circ$ was selected and the relative complex currents I_{21} , I_{32} and I_{31} are plotted on the complex plane with βl_2 as parameter in Fig. 18. The shown outer and inner circle corre-

sponds to the initial ε value and the outer most radials to the initial δ value with light gray color.

Attempting to further reduce the number of possible solutions the following more strict design margins were adopted: $\varepsilon = \pm 6\%$ and $\delta = \pm 2^\circ$, shown with dark gray color regions in Fig. 18. Rerunning [SYN3DIP] a unique solution of $\beta l_2 = 307^\circ$ has been achieved. In this manner, two line segments of different length resulted which exceed the dipoles equal distances of 0.5λ : $l_1 = 0.556\lambda$, $l_2 = 0.853\lambda$. Remarkably, the relative currents have almost unit amplitude and almost equal phase differences, that is, an almost ULA, an EQ-ULA.

Therefore, there is indeed a unique practical array, with the characteristics of Tab. 1 to solve the problem of designing an end-fed EQ-ULA capable to satisfy the imposed pattern constrains.

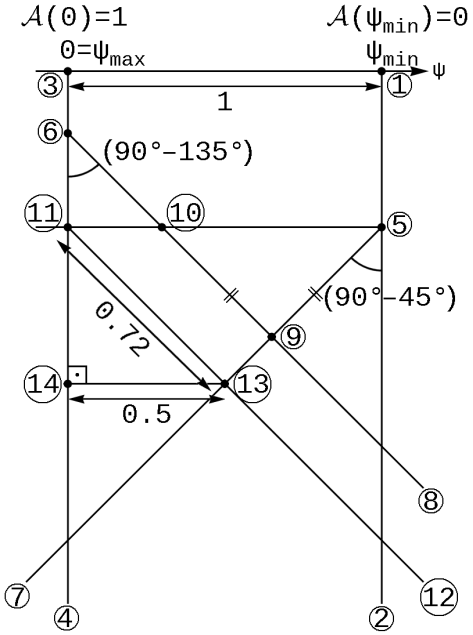

Fig. 13: Geometric technique

if $\mathcal{A}(\psi_{\min}) = 0$ at $\psi_{\min} = 2\pi/3$:

$$\beta d = |13-11| = 0.72 \frac{2\pi}{3} \Rightarrow d \approx 0.25\lambda$$

$$\alpha = |13-14| = 0.50 \frac{2\pi}{3} \Rightarrow \alpha = 60^\circ$$

as in (10) and at $\psi_{\min} = 4\pi/3$:

$$\beta d = |13-11| = 0.72 \frac{4\pi}{3} \Rightarrow d \approx 0.5\lambda$$

$$\alpha = |13-14| = 0.50 \frac{4\pi}{3} \Rightarrow \alpha = 120^\circ$$

Tab. 1: Characteristics and current ratios of EQ-ULA

f	1111 [MHz]		N	3		
L	0.5λ	13.5 [cm]	Min	45°	Max	135°
d	0.5λ	13.5 [cm]	Z_0	200 $[\Omega]$	νf	1
l_1	0.556λ	15 [cm]		l_2	0.853λ	23 [cm]
	$ I_2/I_1 $	$ I_3/I_1 $	$ I_3/I_2 $	$\angle I_2/I_1$	$\angle I_3/I_1$	$\angle I_3/I_2$
	1.058	0.956	0.904	120.4°	-118.8°	120.8°

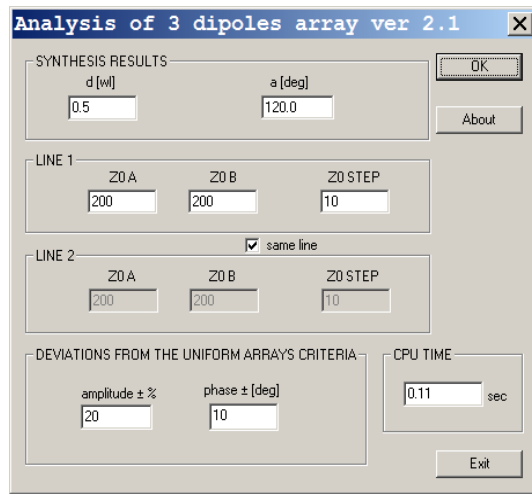

Fig. 14: GUI for Quasi-Uniform Array of N = 3 dipoles

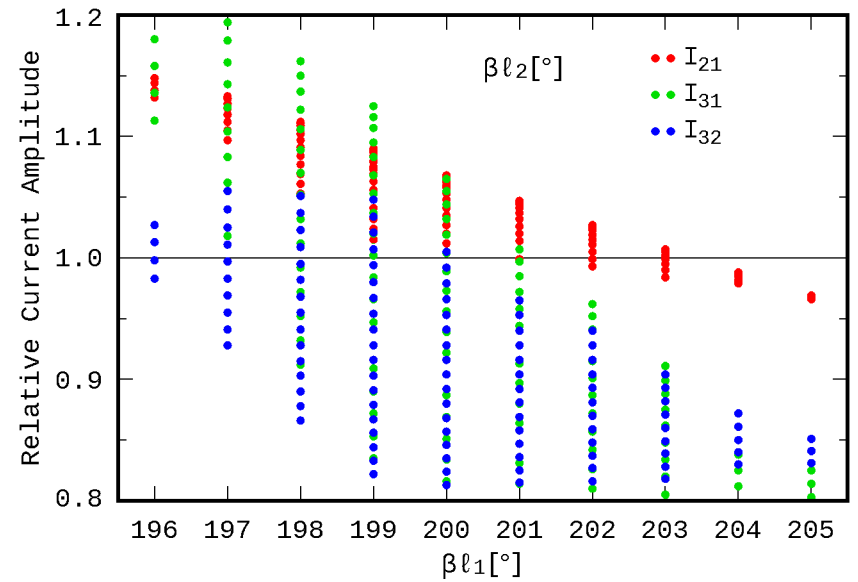

Fig. 16: Amplitude of current ratios for possible β_{l2} values

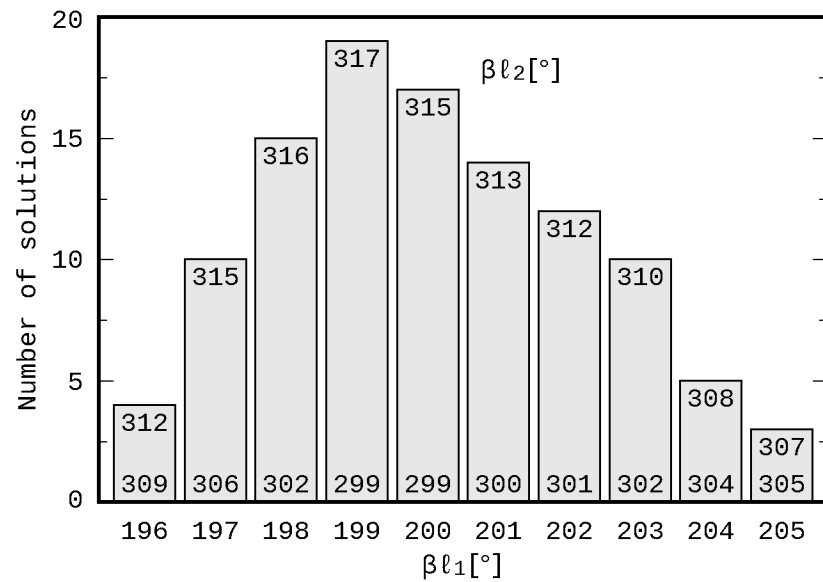

Fig. 15: Possible combinations of β_{l1} , β_{l2}

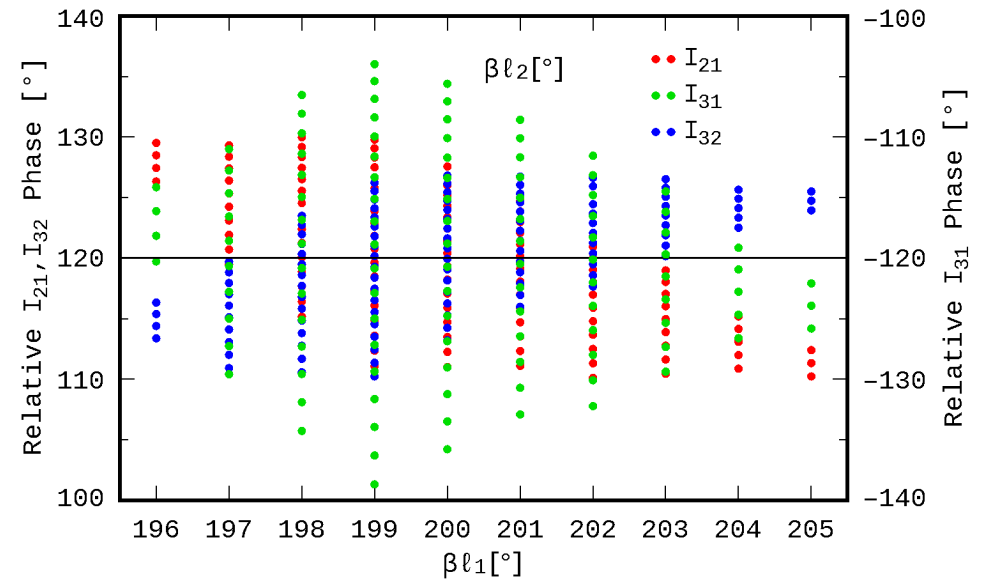

Fig. 17: Phase of current ratios for possible β_{l2} values

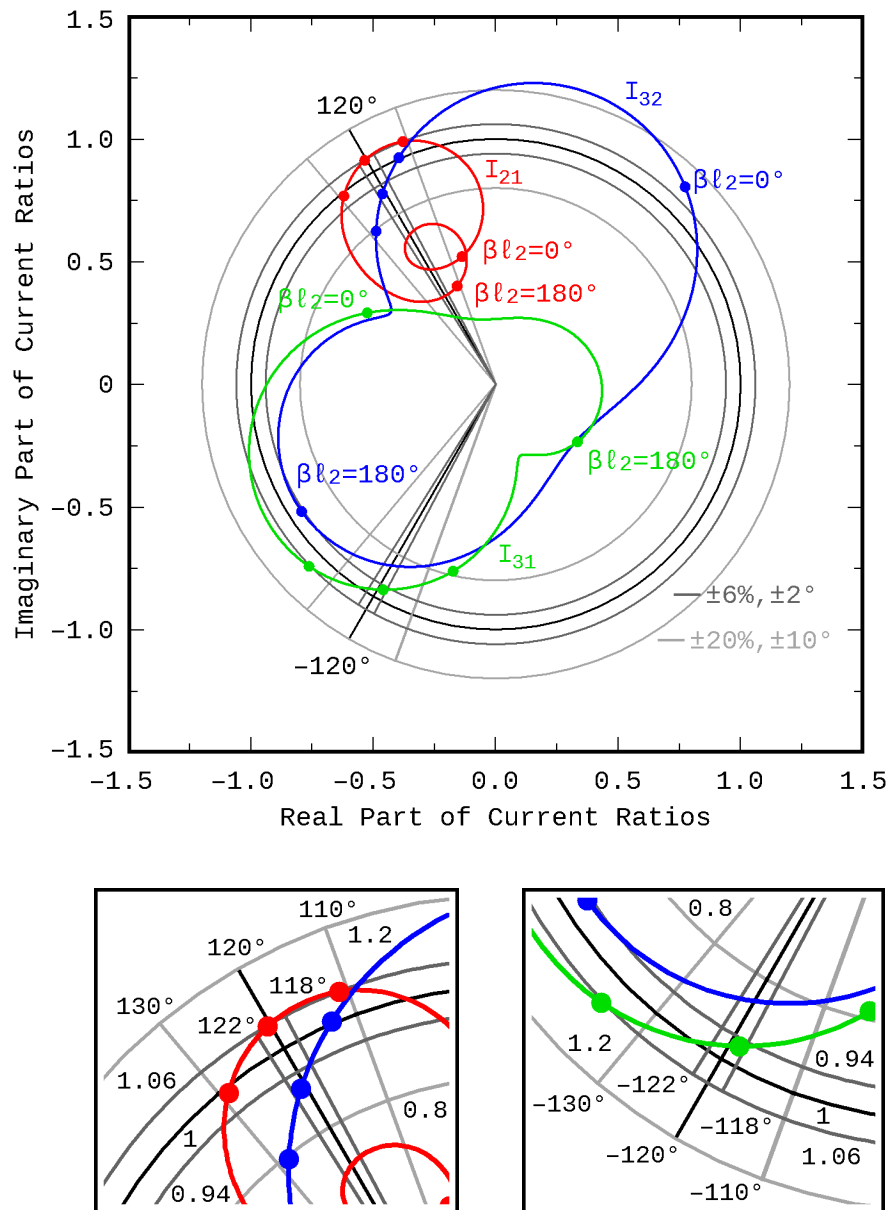

Fig. 18: Currents ratios versus βl_2 with $\beta l_1 = 200^\circ$

Construction and Measurements

The designed EQ-ULA was simulated through the developed application and the [RichWire] simulation program, which is a fully analyzed, corrected and redeveloped edition of the original Moment Method thin-wire computer program [5], [6]. The number of segments for simulation was 72. The construction details and the measurement system are fully described in [2]. The [ANALYZE] application was used for the automated measurements [7], [8]. The simulation model and the constructed antenna are shown in Fig. 19 and in Fig. 20 respectively.

Notably, this array does not have any mechanical support other than its transmission line segments which have an appropriate form capable to achieve a clean self-standing array.

All the results for the 2D radiation pattern cuts by xOy, yOz, and zOx main-planes are shown in Fig. 21(a, b, c), both in Polar and Cartesian map. The scale of Cartesian chart was extended to -40 [dB] in order to include the small values of radiation intensity patterns. In Tab. 2 the maximum values per plane from analysis, simulation and measurement of the correspon-

ding radiation patterns are shown.

Tab. 2: Maximum values

In [dB]	xOy	yOz	zOx
Analytical	-2.99	0.0	-49.23
Richwire	-2.21	0.0	-12.65
Measurement	-5.20	0.0	-6.7

Conclusion

In order to highlight the successful introduction of the idea of Electrical Quasi-Uniform Linear Array, EQ-ULA, using the dipole arrangement presented in this work, the input data and selected output results of [RadPat4W] application for a corresponding strict ULA [1], [5] are shown in Fig. 22.

Zero and maximum directions of ULA array factor were close enough to the required 45° and 135° , respectively. On the other hand, observing the radiation patterns in Fig. 21, especially that of yOz plane which represents the EQ-ULA array factor, there is indeed a zero in 45° from array axis ($\theta = 45^\circ$, $\phi = 90^\circ$), whereas in 135° ($\theta = 45^\circ$, $\phi = 270^\circ$) a maximum indeed exists with a small deviation in experimental results.

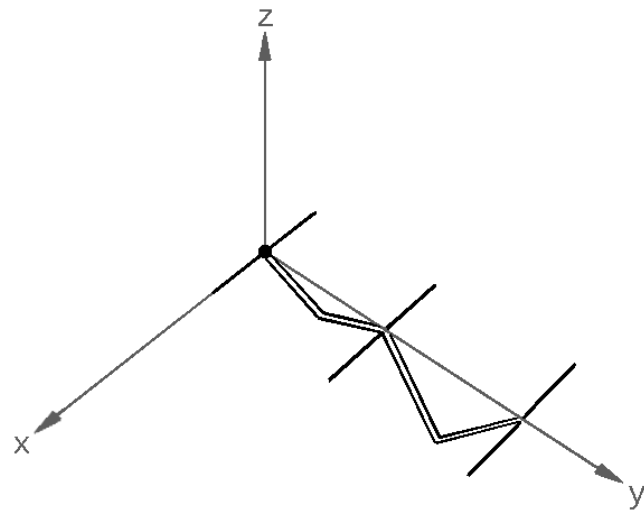

Fig. 19: The simulation model

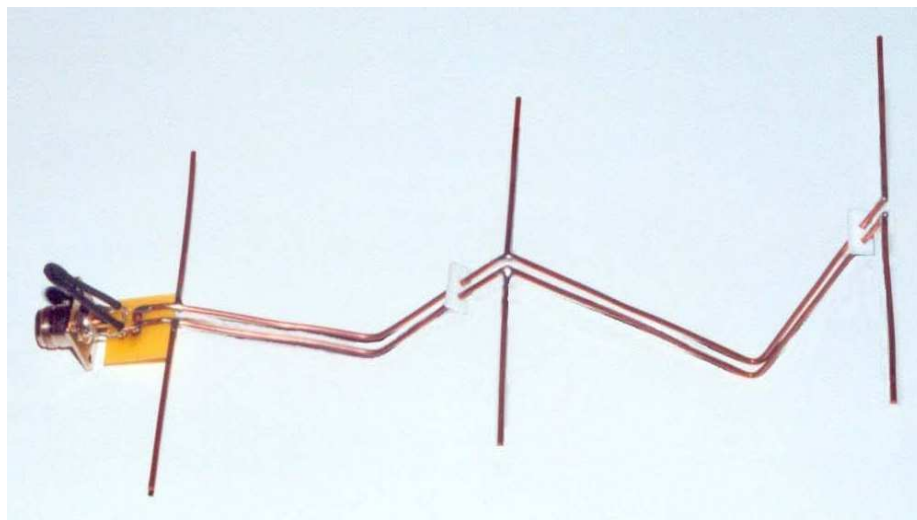

Fig. 20: The antenna array

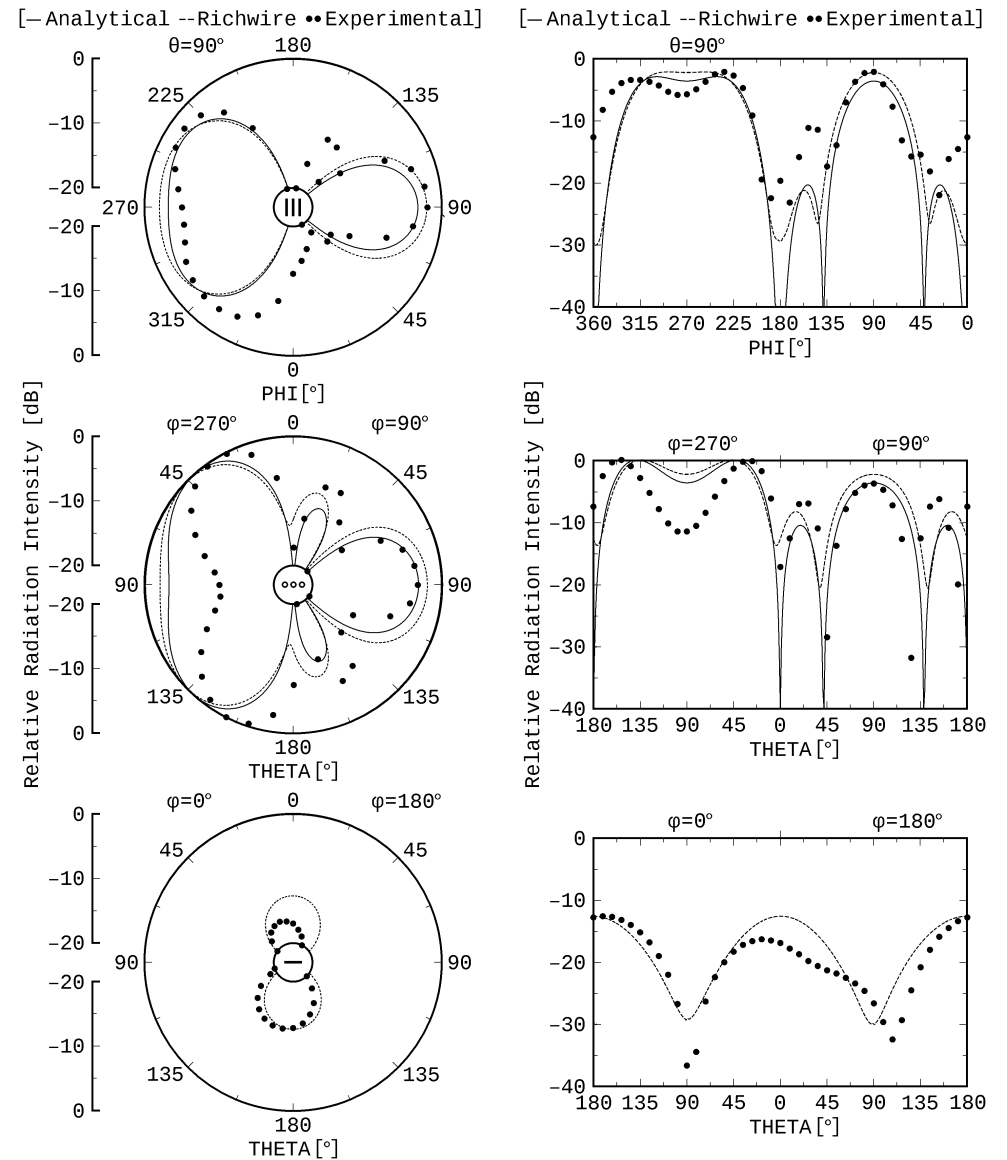

Fig. 21: Analysis, simulation and measurements for the experimental EQ-ULA array

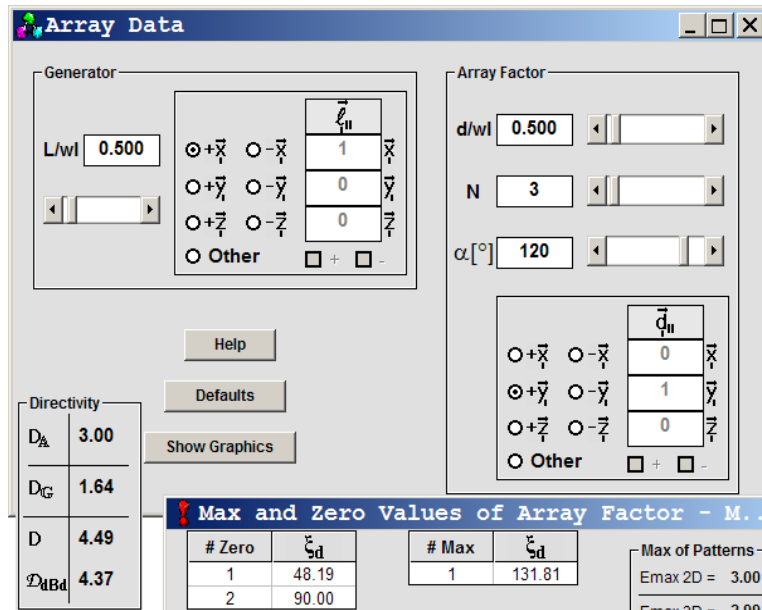

Fig. 22: Array Data of theoretical strict ULA

Fig. 23 contains a comparison regarding radiation patterns of the (i) designed and studied analytically EQ-ULA, (ii) theoretical strict ULA, (iii) simulation results, and (iv) measurements. Under the given measurement circumstances, it is obvious that, the experimental, computational, analytical and theoretical results were found to be in good agreement. The screen captures of the produced Virtual Reality radiation intensity patterns in dB for the array factor \mathcal{A} , the generator \mathcal{G} , and the dipole array \mathcal{E} are given in Fig. 24.

Furthermore, according to the results of our ULA studies [1], if both directions of maximum of generator pattern and array factor coincide, then the antenna array directivity has directivity that it is at least as big as the maximum of the respecting two directivities D_G, D_A . Since generator pattern is maximum everywhere on yOz plane and the array factor is maximum on a cone of 135° around its axis y , this condition is obviously satisfied. But $D_G \approx 1.64$ and $D_A = 3$ so $D \geq 3$. This prediction is successfully verified for (a) ULA which has $D \approx 4.49$, as it was computed by [RadPat4W], and (b) EQ-ULA

which has $D \approx 4.22$, as it results from [RichWire] simulation.

In this work the Quasi-Uniform characteristic, which was introduced regarding the electrical uniformity of an

ULA, was experimentally proved to be a reliable solution to design and construct practical, non-trivial, linear uniform, end-fed, self-standing arrays, with a single driving point.

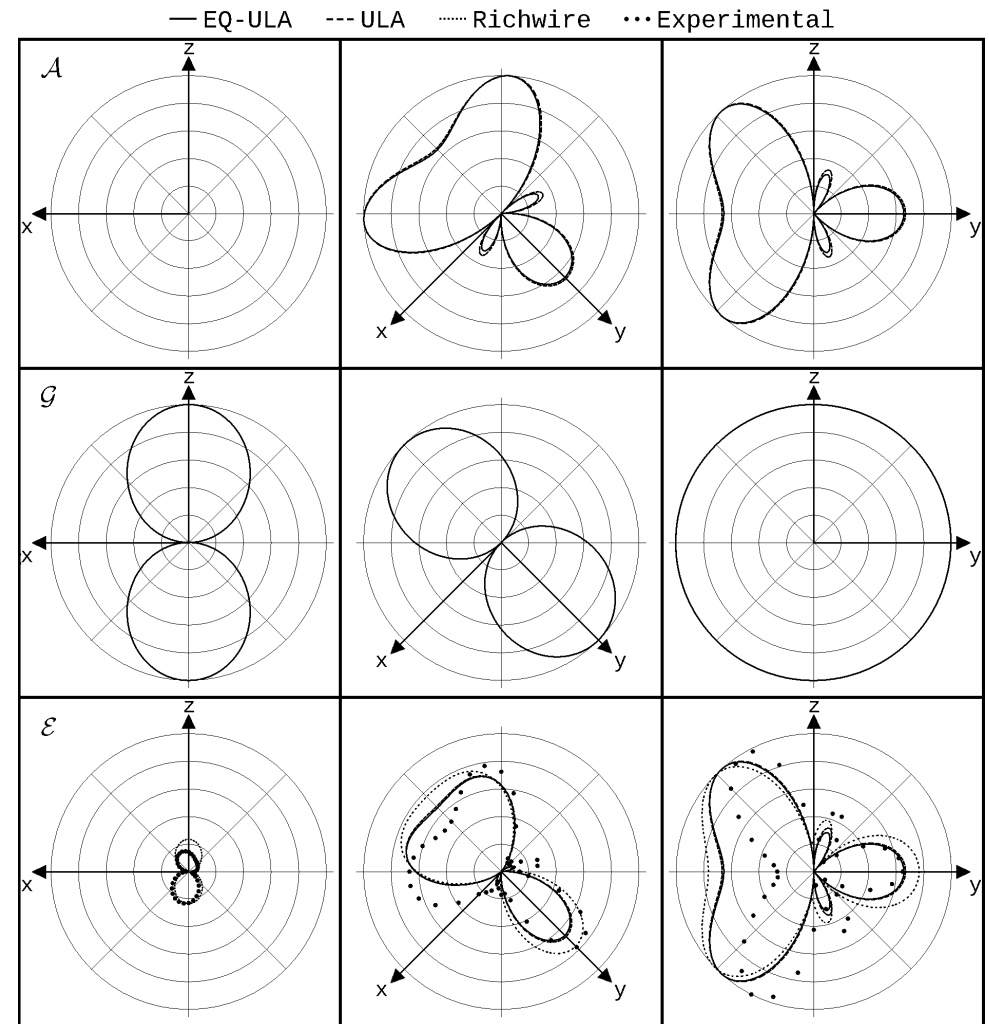

Fig. 23: Normalized 2D radiation patterns $\mathcal{A}, \mathcal{G}, \mathcal{E}$

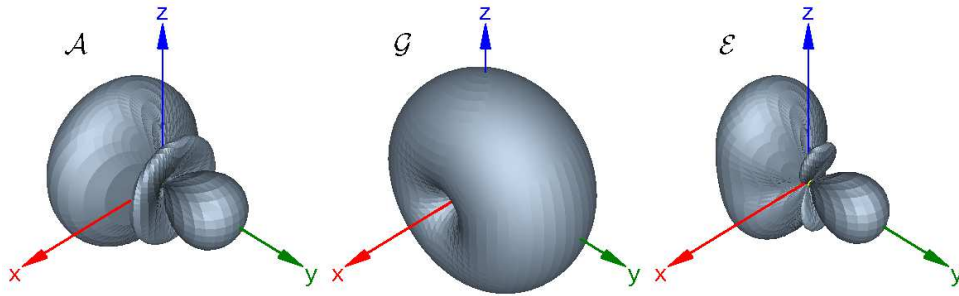

Fig. 24: Multiplication Principle: 3D patterns in dB [5]

References

- [1] Zimourtopoulos P., "Antenna Notes 1999-, Antenna Design Notes 2000-(in Greek)
<https://www.antennas.gr/antennanotes/>
- [2] Kondylis K.Th., Yannopoulou N.I., Zimourtopoulos P.E., "Self-Standing End-Fed Geometrically Uniform Linear Arrays: Analysis, Design, Construction, Measurements and FLOSS", FunkTechnikPlus # Journal, Issue 4, Year 1, 2014, pp. 43-52
<https://www.otoiser.org/index.php/ftpj/article/download/41/36>
- [3] Kondylis K., "Standard Antenna Arrays", Master Thesis #1, ARG-Antennas Research Group, DUTH, 2002 (in Greek)
<https://www.antennas.gr/theses/master/mt1-saa.pdf>
- [4] Kondylis K., "FLOSS for Self-Standing Linear Arrays of Dipoles"
<https://arg.op4.eu/software/efa-eq-ula/eeu-src-exe-vr.7z>
<https://sourceforge.net/projects/antennas/files/efa-eq-ula/eeu-src-exe-vr.7z>
<https://www.antennas.gr/floss/EndFedArrays/>
- [5] Yannopoulou N., Zimourtopoulos P., "A FLOSS Tool for Antenna Radiation Patterns", Proceedings of 15th Conference on Microwave Techniques, COMITE 2010, Brno, Czech Republic, pp. 59-62

Yannopoulou N.I., Zimourtopoulos P.E., "Antenna Radiation Patterns: RadPat4W – FLOSS for MS Windows or Wine Linux", FunkTechnikPlus # Journal, Issue 5, Year 2, 2014, pp. 33-45
<https://www.otoiser.org/index.php/ftpj/article/download/47/42>

- [6] Richmond J.H., "Computer program for thin-wire structures in a homogeneous conducting medium", Publication Year: 1974, NTRS-Report/Patent Number: NASA-CR-2399, ESL-2902-12, DocumentID: 19740020595
<https://ntrs.nasa.gov/search.jsp?R=19740020595>
- [7] Yannopoulou N., Zimourtopoulos P., "ANALYZE: Automated Antenna Measurements, ver. 13", Antennas Research Group, 1993-2008
- [8] Yannopoulou N., Zimourtopoulos P., "S-Parameter Uncertainties in Network Analyzer Measurements with Application to Antenna Patterns", Radioengineering, Vol. 17, No. 1, April 2008, pp. 1-8
https://www.radioeng.cz/fulltexts/2008/08_01_01_08.pdf

*Active Links: 30.09.2018

Previous Publication in FUNKTECHNIKPLUS # JOURNAL

"Measurement Uncertainty in Network Analyzers: Differential Error DE Analysis of Error Models Part 5: Step-by-Step Graphical Construction of Complex DE Regions and Real DE Intervals", Issue 16, pp. 7-25

* About The Authors

Konstantinos Kondylis, Issue 4, Year 1, p. 52
kkondylis@gmail.com

Nikolitsa Yannopoulou, Issue 9, Year 3, p. 390
yin@arg.op4.eu

Petros Zimourtopoulos, Issue 9, Year 3, p. 390
pez@arg.op4.eu

This paper is licensed under a Creative Commons Attribution 4.0 International License – <https://creativecommons.org/licenses/by/4.0/>

[This Page Intentionally Left Blank]

[This Page Intentionally Left Blank]

[This Page Intentionally Left Blank]

[This Page Intentionally Left Blank]

In case of any doubt,
download the genuine papers from
genuine.ftpj.otoiser.org

FRONT COVER VIGNETTE

A faded synthesis of an anthemion rooted in a meandros

The thirteen-leaf is a symbol for a life tree leaf.
"Herakles and Kerberos", ca. 530–500 BC,
by Paseas, the Kerberos Painter,
Museum of Fine Arts, Boston.

www.mfa.org/collections/object/plate-153852

The simple meandros is a symbol for eternal immortality.
"Warrior with a phiale", ca. 480–460 BC,
by Berliner Maler,
Museo Archeologico Regionale "Antonio Salinas" di Palermo.

commons.wikimedia.org/wiki/File:Warrior_MAR_Palermo_NI2134.jpg

ARG NfP AoI

Antennas Research Group

Not-for-Profit Association of Individuals [*]

www.arg.op4.eu – arg@op4.eu

Hauptstraße 52, 2831 Scheiblingkirchen, Austria

Telephone: 0 6646311483 – International: 0043 6646311483

* The Constitution of Greece, Article 12(3) – 2008:

www.hellenicparliament.gr/en/Vouli-ton-Ellinon/To-Politevma

* The Hellenic Supreme Court of Civil and Penal Law:

www.areiospagos.gr/en – [Court Rulings:Civil|A1|511|2008](http://www.areiospagos.gr/en/Court-Rulings:Civil|A1|511|2008)